

Infinite System Specification

— Diamond series

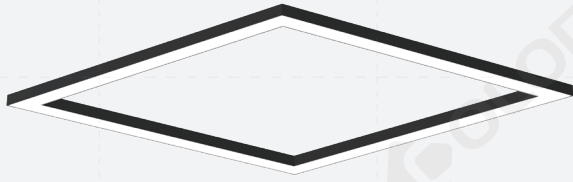

D-RS3535D
D-RS5035D
D-RS7035D
D-RS3535P
D-RS5035P
D-RS7035P



Optical: Diffuser

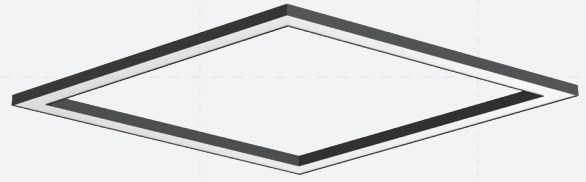

Optical: Prismatic

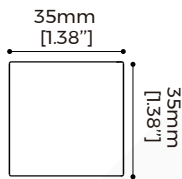

Model:
D-RS3535D
D-RS3535P

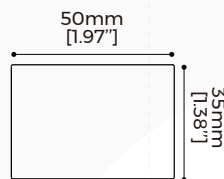

Model:
D-RS5035D
D-RS5035P

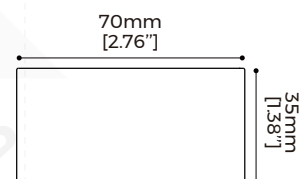

Model:
D-RS7035D
D-RS7035P

© Basic Information

Light efficiency

D-RS3535D 100LM/W(Regular), 120LM/W(High-Efficiency)	D-RS3535P 85LM/W(Regular), 105LM/W(High-Efficiency)
D-RS5035D 100LM/W(Regular), 120LM/W(High-Efficiency)	D-RS5035P 90LM/W(Regular), 105LM/W(High-Efficiency)
D-RS7035D 110LM/W(Regular), 135LM/W(High-Efficiency)	D-RS7035P 100LM/W(Regular), 120LM/W(High-Efficiency)

Common information

· Material:	AL6063-T5, spraying surface
· Color:	Black/White/Silver/Orange/Blue/Green /Rose gold/Champagne gold
· Side length:	600/900/1200mm optional
· IP grade:	IP20
· CCT:	2700/3000/3500/4000/5000/6500K optional
· CRI:	>80/>90
· SDCM:	≤3 Step
· Dimming method:	Non-dimming, 1-10V, DALI2+PUSH
· Application:	Indoor
· Installation:	Ceiling/Pendant
· Certification:	CE, UKCA, ROHS, REACH, CB, ENEC, ETL, LM-80
· Warranty:	5 years

© Product Dimension Information

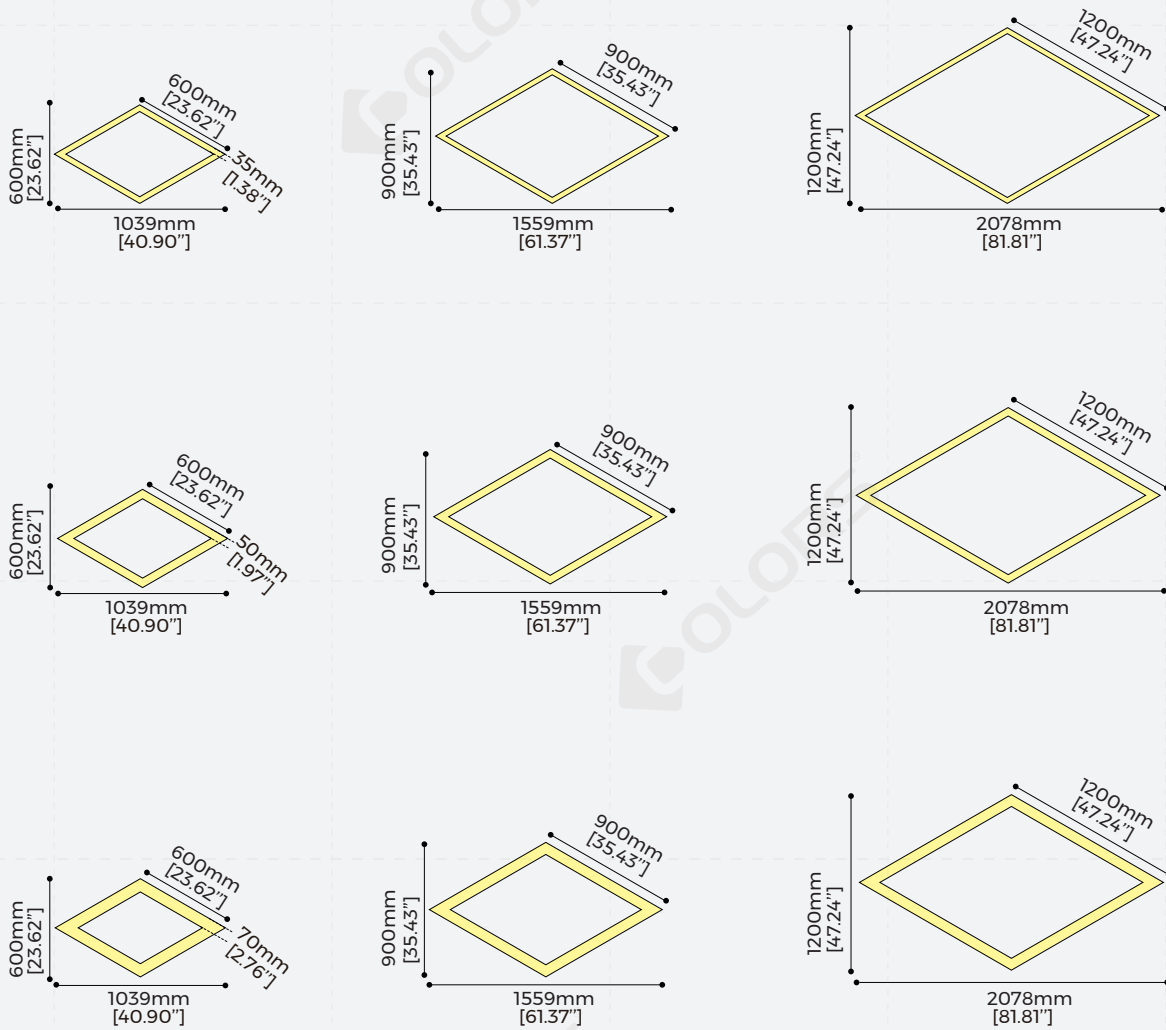

*The yellow fill means luminous surface.

*For side length < 900mm, the lamp is to be produced as complete unit.

*For side length ≥ 900mm, the lamp is to be divided into parts as following:

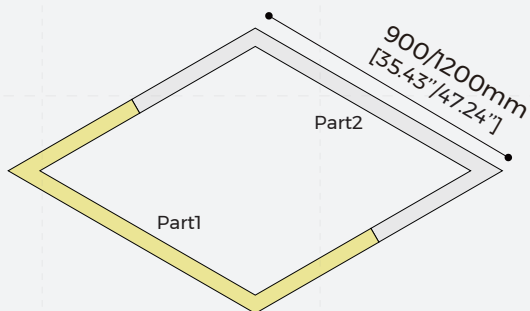

© Luminaire Parameters

Model	Version	Length (mm)	Type Power (W/PCS)	Input Voltage (V)	Input Current (mA)	CRI	Lumens (LM/PCS)	CCT
D-RS3535D	Regular	600 [1.97ft]	48	AC200-240V	240	>80	4800	2700K 3000K 3500K 4000K 5000K 6500K
						>90	4128	
		900 [2.95ft]	70	AC200-240V	350	>80	7000	
						>90	6020	
		1200 [3.94ft]	94	AC200-240V	470	>80	9400	
						>90	8084	
	High-Efficiency	600 [1.97ft]	48	AC200-240V	240	>80	5760	
						>90	4954	
		900 [2.95ft]	70	AC200-240V	350	>80	8400	
						>90	7224	
		1200 [3.94ft]	94	AC200-240V	470	>80	11280	
						>90	9701	
D-RS3535P	Regular	600 [1.97ft]	48	AC200-240V	240	>80	4080	
						>90	3509	
		900 [2.95ft]	70	AC200-240V	350	>80	5950	
						>90	5117	
		1200 [3.94ft]	94	AC200-240V	470	>80	7990	
						>90	6871	
	High-Efficiency	600 [1.97ft]	48	AC200-240V	240	>80	5040	
						>90	4334	
		900 [2.95ft]	70	AC200-240V	350	>80	7350	
						>90	6321	
		1200 [3.94ft]	94	AC200-240V	470	>80	9870	
						>90	8488	

Model	Version	Length (mm)	Type Power (W/PCS)	Input Voltage (V)	Input Current (mA)	CRI	Lumens (LM/PCS)	CCT
D-RS5035D	Regular	600 [1.97ft]	58	AC200-240V	290	>80	5800	2700K 3000K 3500K 4000K 5000K 6500K
						>90	4988	
		900 [2.95ft]	90	AC200-240V	450	>80	9000	
						>90	7740	
		1200 [3.94ft]	116	AC200-240V	590	>80	11600	
						>90	9976	
	High-Efficiency	600 [1.97ft]	58	AC200-240V	290	>80	6960	
						>90	5986	
		900 [2.95ft]	90	AC200-240V	450	>80	10800	
						>90	9288	
		1200 [3.94ft]	116	AC200-240V	590	>80	13920	
						>90	11971	
D-RS5035P	Regular	600 [1.97ft]	58	AC200-240V	290	>80	5220	
						>90	4489	
		900 [2.95ft]	90	AC200-240V	450	>80	8100	
						>90	6966	
		1200 [3.94ft]	116	AC200-240V	590	>80	10440	
						>90	8978	
	High-Efficiency	600 [1.97ft]	58	AC200-240V	290	>80	6090	
						>90	5237	
		900 [2.95ft]	90	AC200-240V	450	>80	9450	
						>90	8127	
		1200 [3.94ft]	116	AC200-240V	590	>80	12180	
						>90	10475	

Model	Version	Length (mm)	Type Power (W/PCS)	Input Voltage (V)	Input Current (mA)	CRI	Lumens (LM/PCS)	CCT
D-RS7035D	Regular	600 [1.97ft]	78	AC200-240V	390	>80	8580	2700K 3000K 3500K 4000K 5000K 6500K
						>90	7379	
		900 [2.95ft]	116	AC200-240V	590	>80	12760	
						>90	10974	
		1200 [3.94ft]	156	AC200-240V	790	>80	17160	
						>90	14758	
	High-Efficiency	600 [1.97ft]	78	AC200-240V	390	>80	10530	
						>90	9056	
		900 [2.95ft]	116	AC200-240V	590	>80	15660	
						>90	13468	
		1200 [3.94ft]	156	AC200-240V	790	>80	21060	
						>90	18112	
D-RS7035P	Regular	600 [1.97ft]	78	AC200-240V	390	>80	7800	
						>90	6708	
		900 [2.95ft]	116	AC200-240V	590	>80	11600	
						>90	9976	
		1200 [3.94ft]	156	AC200-240V	790	>80	15600	
						>90	13416	
	High-Efficiency	600 [1.97ft]	78	AC200-240V	390	>80	9360	
						>90	8050	
		900 [2.95ft]	116	AC200-240V	590	>80	13920	
						>90	11971	
		1200 [3.94ft]	156	AC200-240V	790	>80	18720	
						>90	16099	

Note:

1. The output data is based on white coated luminaire with Ra80,4000K.
2. The above lumens data are at 4000K color temperature.
3. High-efficiency version does not do 3500K and 5000K.
4. The tolerance of output data can be vary up to 15%.
5. The output data is typical value.
6. The following is an example of lumen conversion instructions:

CCT	RA	Ratio of lumens (white coated luminaire)	Ratio of lumens (Other coated colors of luminaire)
2700K	80	90%	Calculate white coated luminaire lumens first, then multiply by 90 %
	90	77%	
3000K	80	93%	
	90	80%	
3500K	80	97%	
	90	83%	
4000K	80	100%	
	90	86%	
5000K	80	100%	
	90	86%	
6500K	80	100%	
	90	86%	

Note: All other lumens are to be based on white coated luminaire with 4000K,RA80(100%),and multiplied by the percentage in the table above.

Assuming a 4000K, RA80 white coated luminaire with 1000lm lumens:

Example 1: If you need 4000K,RA90 lumens (white coated luminaire)	$1000 \times 86\% = 860\text{lm}$
Example 2: If you need 4000K,RA90 lumens (other coated colors of luminaire)	$1000 \times 86\% \times 90\% = 774\text{lm}$
Example 3: If you need 3000K,RA80 lumens (white coated luminaire)	$1000 \times 93\% = 930\text{lm}$
Example 4: If you need 3000K,RA90 lumens (white coated luminaire)	$1000 \times 80\% = 800\text{lm}$
Example 5: If you need 5000K,RA80 lumens (white coated luminaire)	$1000 \times 100\% = 1000\text{lm}$

© Optical Parameter

[D-RS3535D]

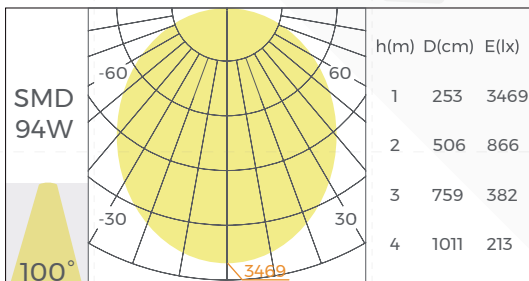

Regular version

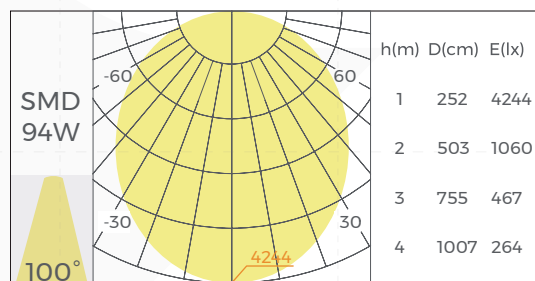

High-efficiency version

*The above data is based on a 1200mm length luminaire with Ra80,4000K.

【D-RS3535P】

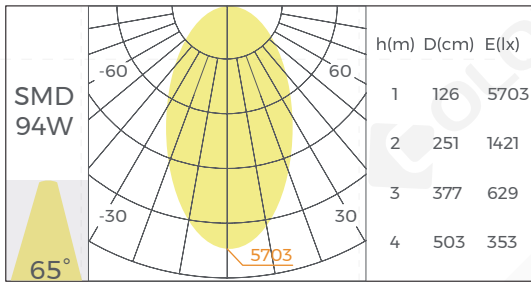

Regular version

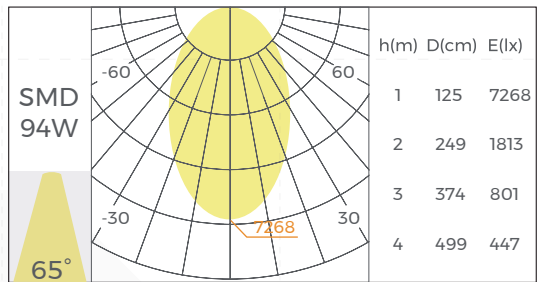

High-efficiency version

*The above data is based on a 1200mm length luminaire with Ra80,4000K.

【D-RS5035D】

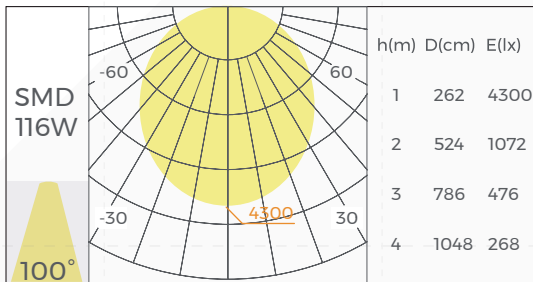

Regular version

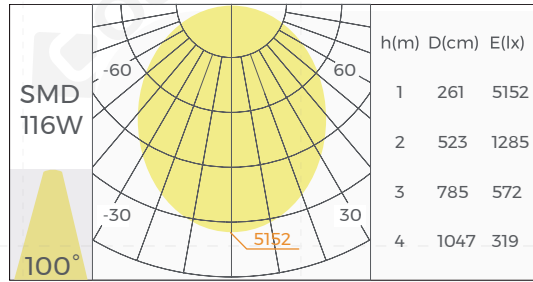

High-efficiency version

*The above data is based on a 1200mm length luminaire with Ra80,4000K.

【D-RS5035P】

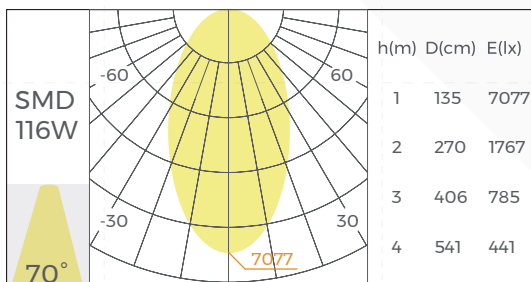

Regular version

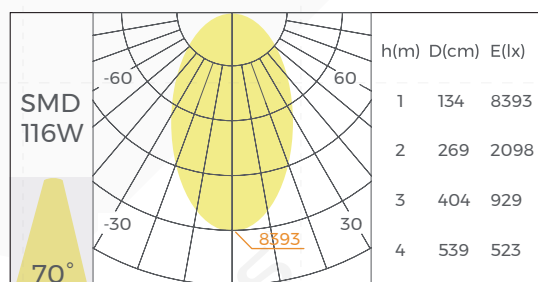

High-efficiency version

*The above data is based on a 1200mm length luminaire with Ra80,4000K.

【D-RS7035D】

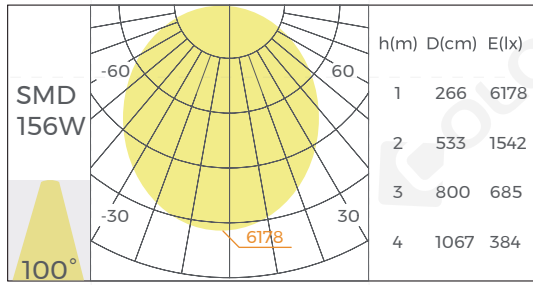

Regular version

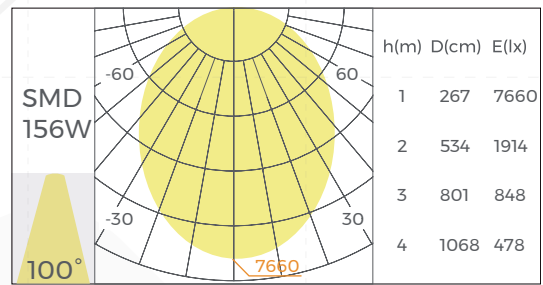

High-efficiency version

*The above data is based on a 1200mm length luminaire with Ra80,4000K.

【D-RS7035P】

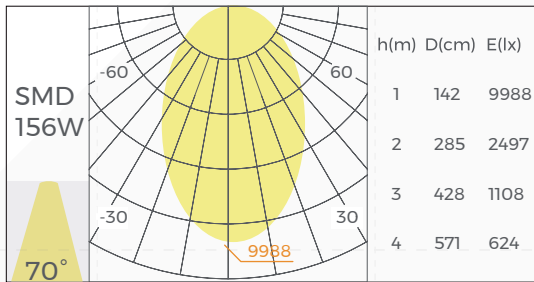

Regular version

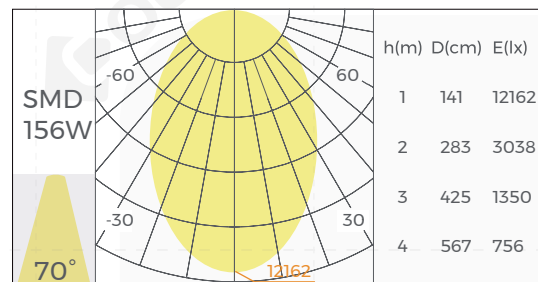

High-efficiency version

*The above data is based on a 1200mm length luminaire with Ra80,4000K.

◎ Installation

External power supply



Ceiling

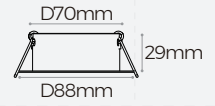
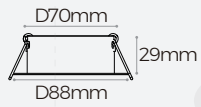

Ceiling plate
(With Steel Wire Rope)



Ceiling plate
(With Rod)

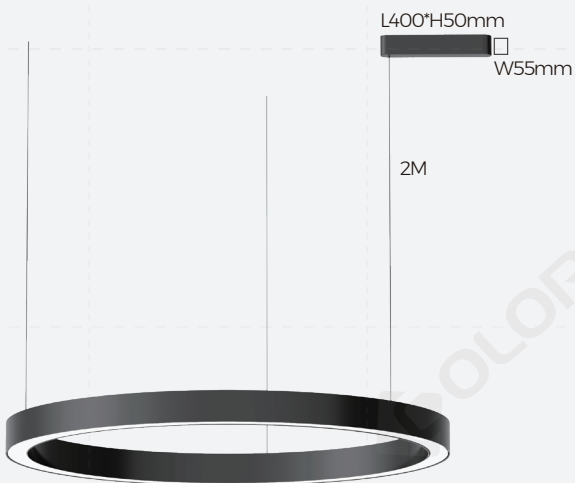

Linear Power Box
(With Steel Wire Rope)

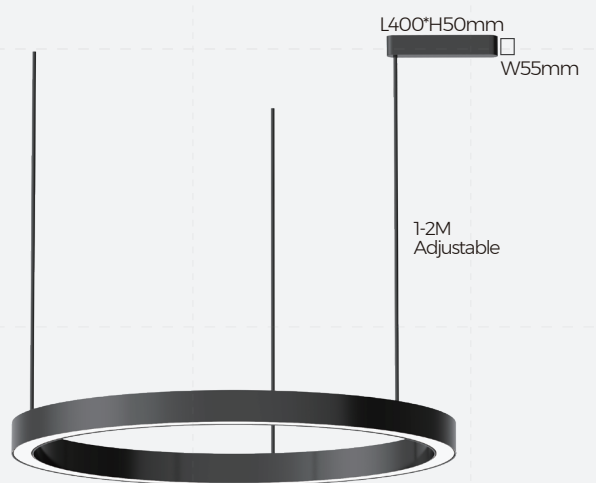

Linear Power Box
(With Rod)

- Note:
1. The above illustration shows the installation method.
 2. The above luminaire shapes are for installation illustration only.













© Packing

Model	Quantity (PCS/carton)	NW (kg/carton)	GW (kg/carton)	Size (mm/carton)
D-RS3535D0600(R)-N840W048	4	7.20	9.60	1090*660*380 [42.91"*25.98"*14.96"]
D-RS3535D0900(R)-N840W070	4	10.80	14.00	1180*480*380 [46.45"*18.89"*14.96"]
D-RS3535D1200(R)-N840W094	4	14.40	18.40	1560*580*380 [61.41"*22.83"*14.96"]
D-RS5035D0600(R)-N840W058	4	9.12	11.52	1090*660*380 [42.91"*25.98"*14.96"]
D-RS5035D0900(R)-N840W090	4	13.68	16.88	1180*480*380 [46.45"*18.89"*14.96"]
D-RS5035D1200(R)-N840W116	4	18.24	22.24	1560*580*380 [61.41"*22.83"*14.96"]
D-RS7035D0600(R)-N840W078	4	10.94	13.34	1090*660*380 [42.91"*25.98"*14.96"]
D-RS7035D0900(R)-N840W116	4	16.42	19.62	1180*480*380 [46.45"*18.89"*14.96"]
D-RS7035D1200(R)-N840W156	4	21.89	25.89	1560*580*380 [61.41"*22.83"*14.96"]

Note:

- Lamps packaged without inner box, directly use the outer box.
- The above weight data is for reference, the exact data should be based on the weight of the physical weighing shall prevail.

© Model Code

D	-	R	S	3535	D	1200	(R)	-	N	8	40	B	-	094
														
Series A: Arc series C: Circle series S: Square series W: Wave series T: Triangle series H: Hexagon series D: Diamond series		Type R: Right angle C: Curve angle	Installation E: Recessed S: Ceiling/Pendant	Size 3535: 35mm Luminous surface width 35mm Lamp height	Optical Type D: Diffuser P: Prismatic	Length 1200: 1200mm	Version (R): Regular (H): High-efficiency		Dimming Method N: Non-dimming D: 1-10V A: DALI	CRI 8: Ra>80 9: Ra>90	CCT 27: 2700K 30: 3000K 40: 4000K	Color B: Black W: White S: Silver		Type power 094: 94W

© **Attentions**

- 1、 Non-professionals are prohibited from installing, disassembling and repairing the product.
- 2、 Avoid scratching, distortion and irregular bending of the product during installation; otherwise it may cause irreparable damage to the product.
- 3、 Please use professional cutting tools when cutting
- 4、 Do not use any acid or alkaline adhesive to fix products
- 5、 The product is only suitable for indoor dry places, can not be used in outdoor, seaside or wet environment.
- 6、 PC features: Each 10°C rise or drop will make diffuser extend or shrink 0.8mm/m, please confirm before processing and use